



<N! *, \$



赫兹电力
HERTZ POWER



HZ-680

m



赫兹电力
HERTZ POWER

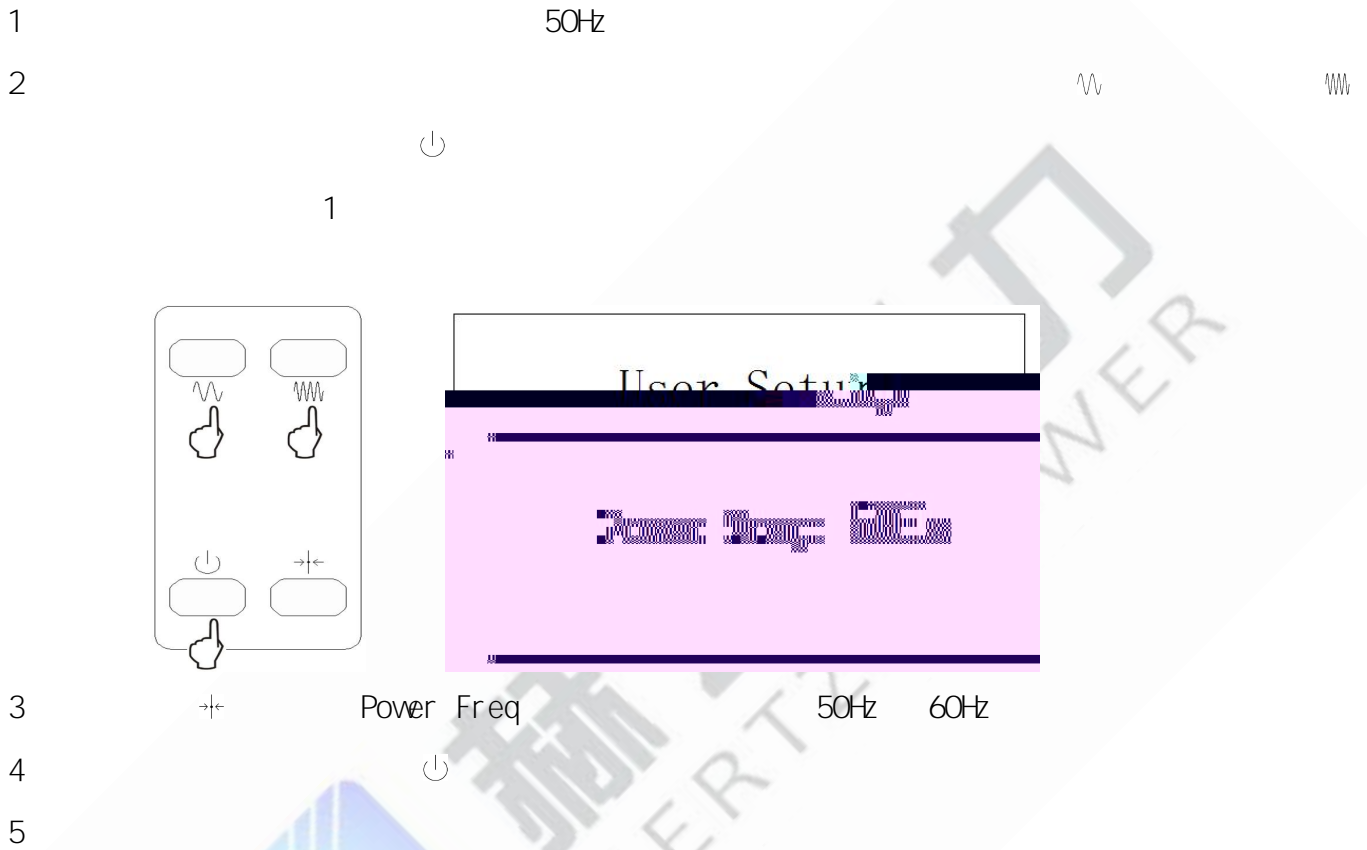

HZ-680



1-1-1

- 5. 800x480 121x76mm
- 6. 2 18650 3. 7V 6. 8Ah



- 1. 280x 220x 90mm 220x 125x 55mm
- 2. 2. 3kg 0. 9kg
- 3. AC100- 240V 50/60Hz DC8. 4V/2A
- 4. AC100- 240V 50/60Hz DC5V/ 2A
- 5. : - 10 40 5- 90%RH <4500m

1

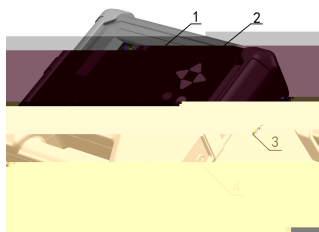

1-4-1

- 1. LCD
- 2.
- 3.
- 4.

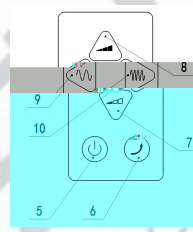

1-4-2

- 5.
- 6.
- 7/8. /
- 9/10. /

2

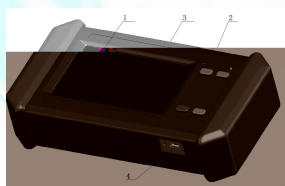

1-5-1

- 1. LCD
- 2.
- 3.
- 4.

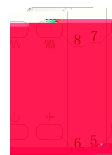

1-5-2

- 5.
- 6.
- 7.
- 8.



1

5

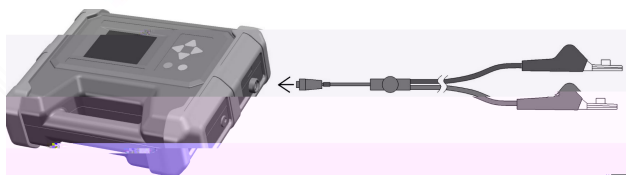

2-1-1



2



输出禁止标志

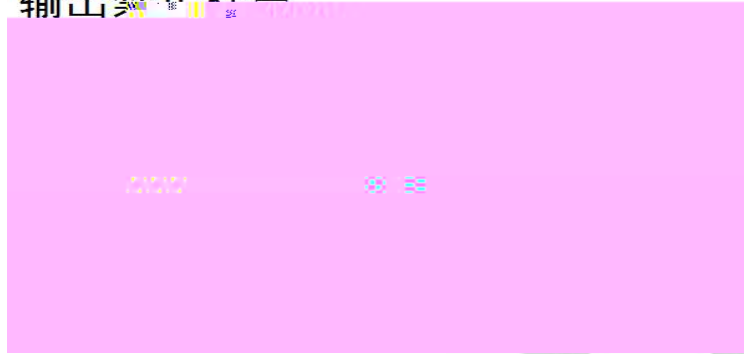

2-1-2

连续输出标志

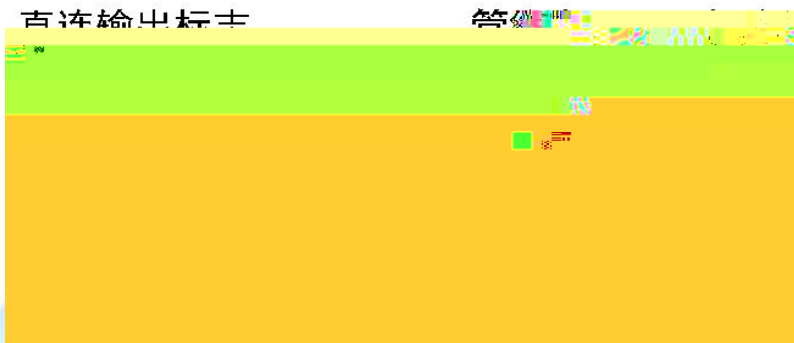

2-1-3

50V

超压警告标志



2-1-4

1

5

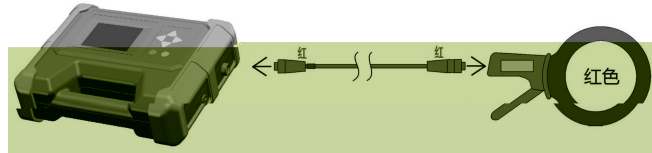

2-2-1

2

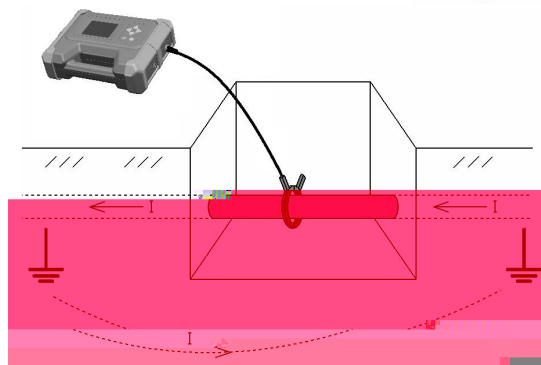

2-2-2

3

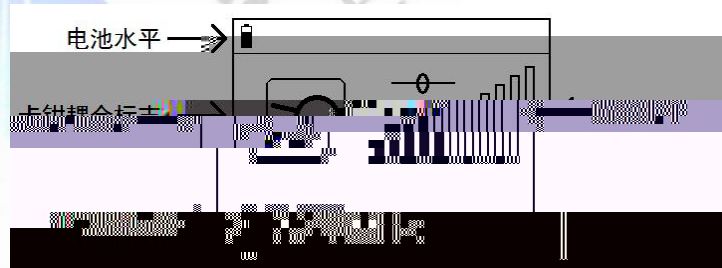

2-2-3

4



640Hz

1280Hz

1280Hz

5



10

1

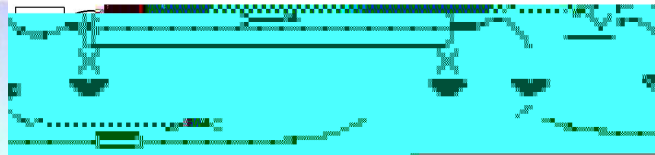
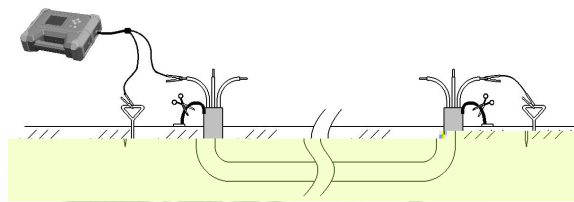

3-1-1

2

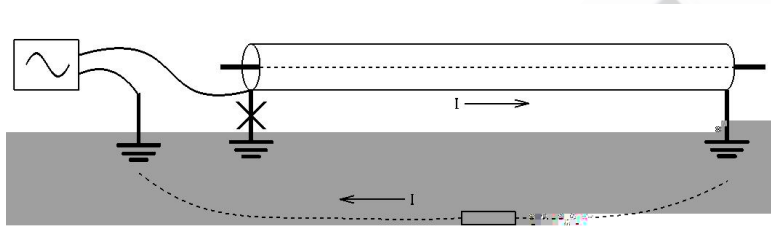
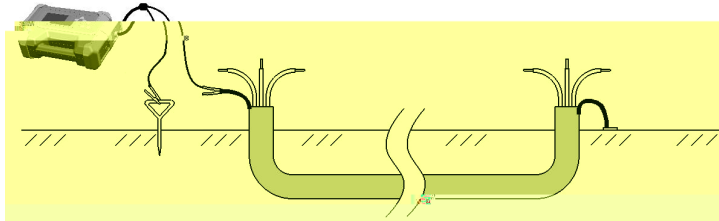

3-1-2

3

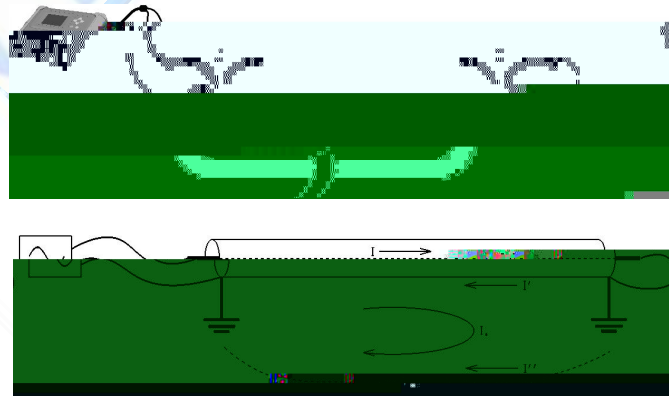

3-1-3

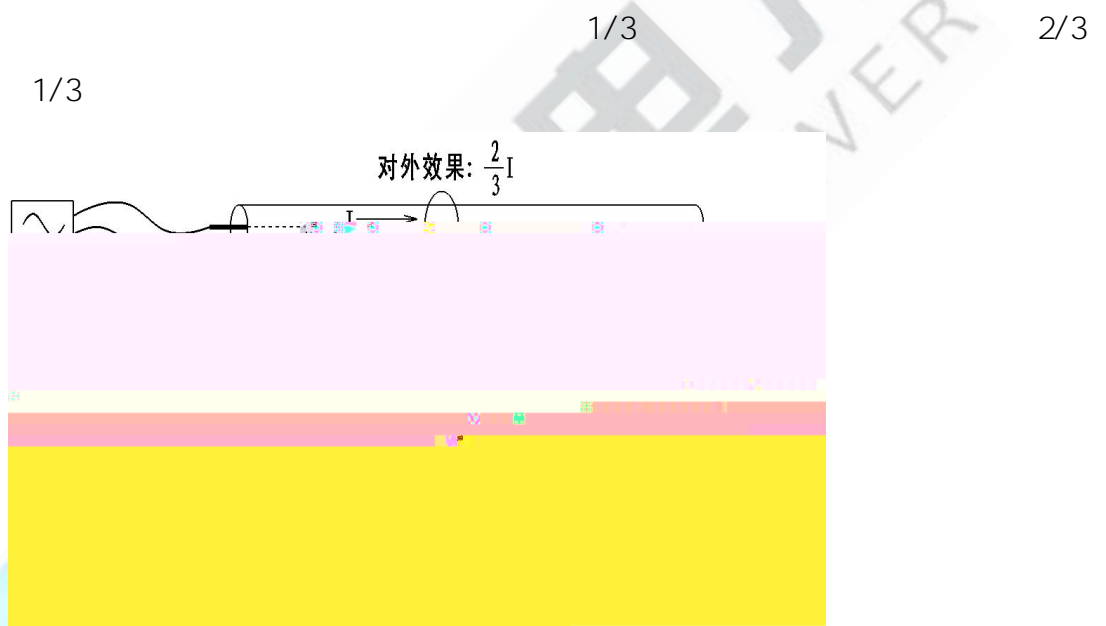

3-1-4

4



1280Hz

1280Hz

640Hz



2-3km

1280Hz

640Hz

225

027-83267669



- 640Hz
- 1280Hz

1

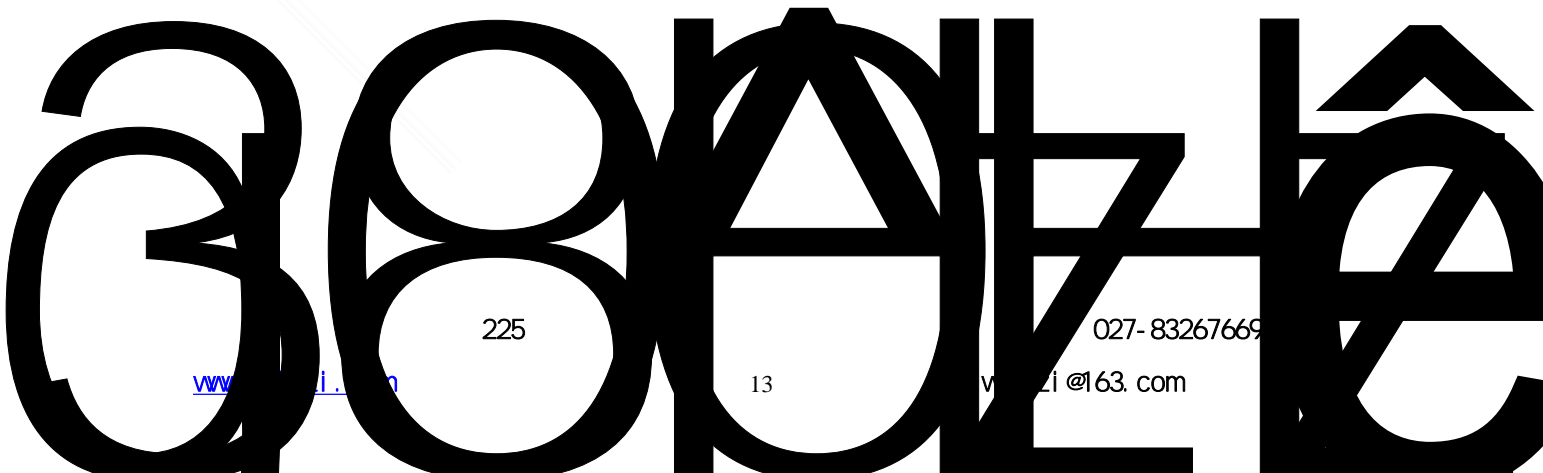
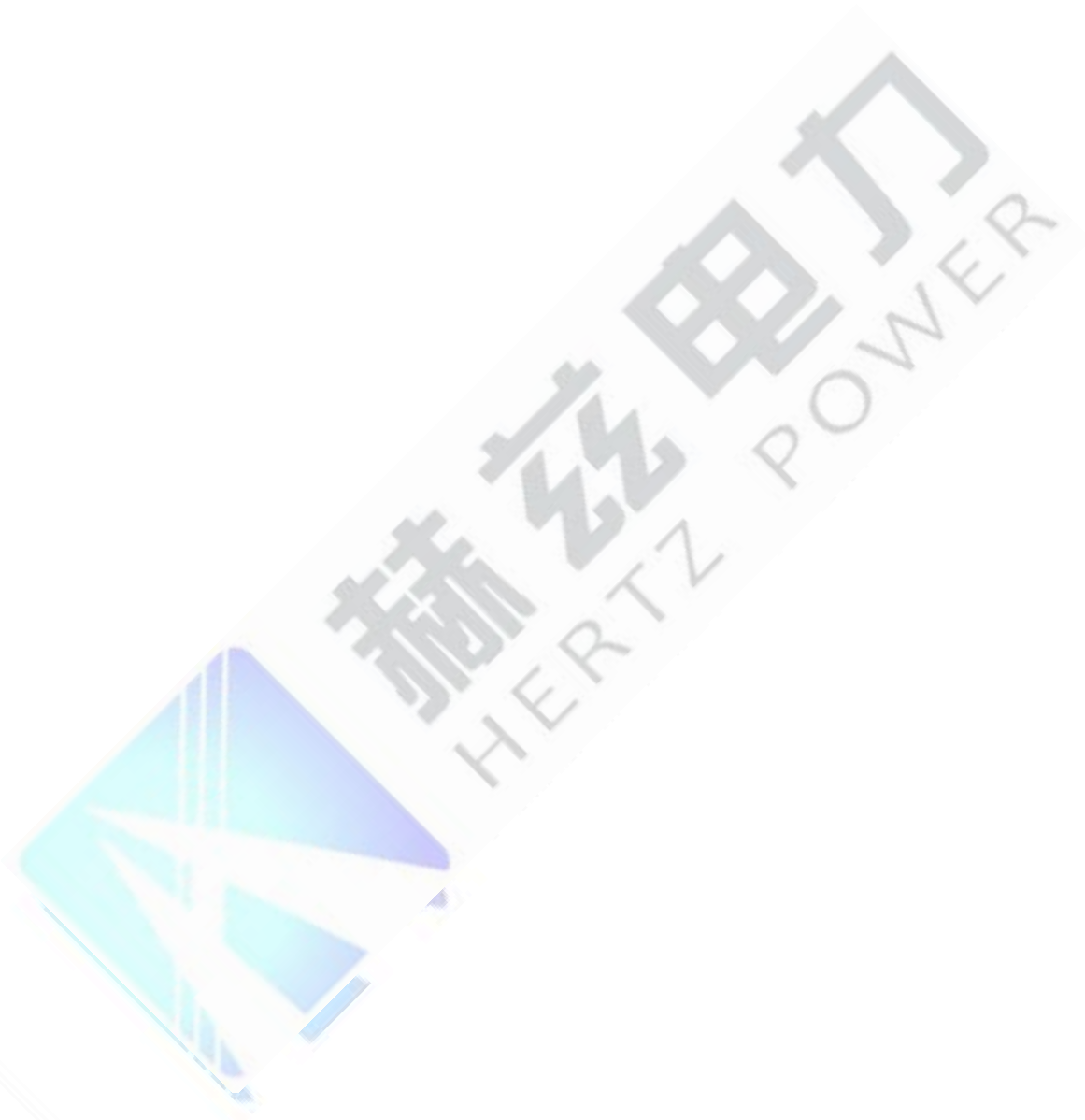

2

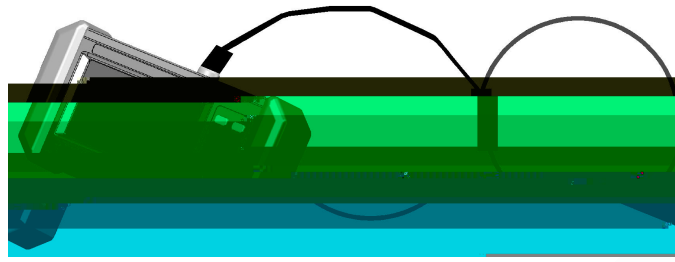

4-1-1

3

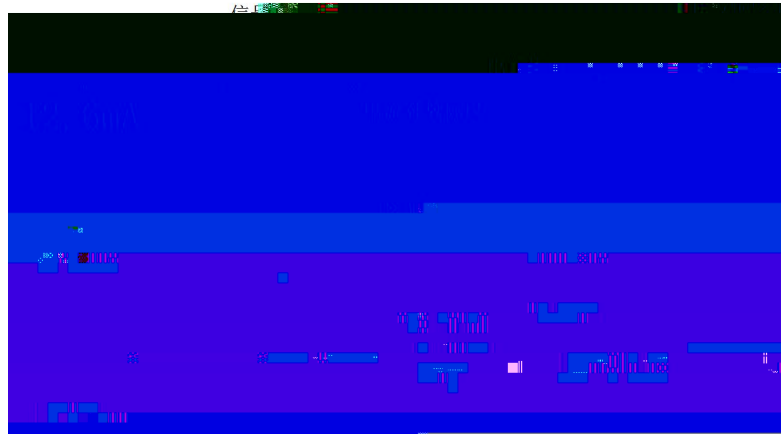

4-1-2

1280Hz

4

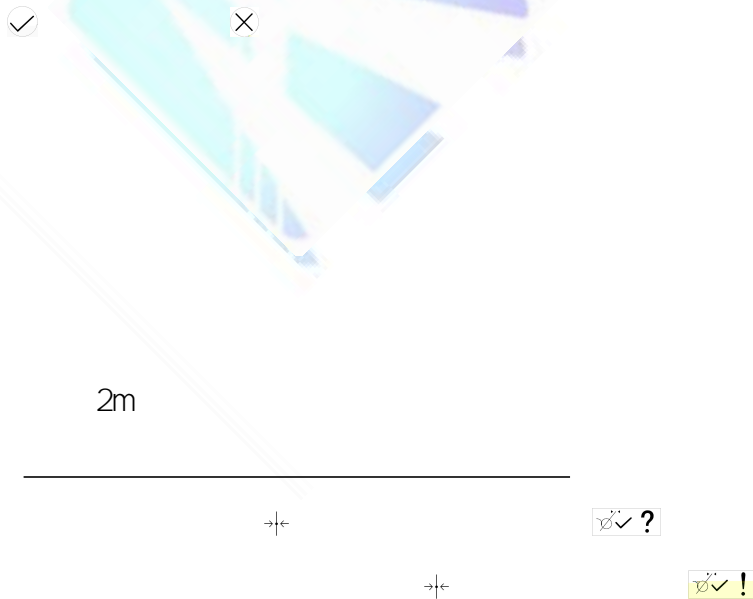

0°



5

- 75 120%
- 45°

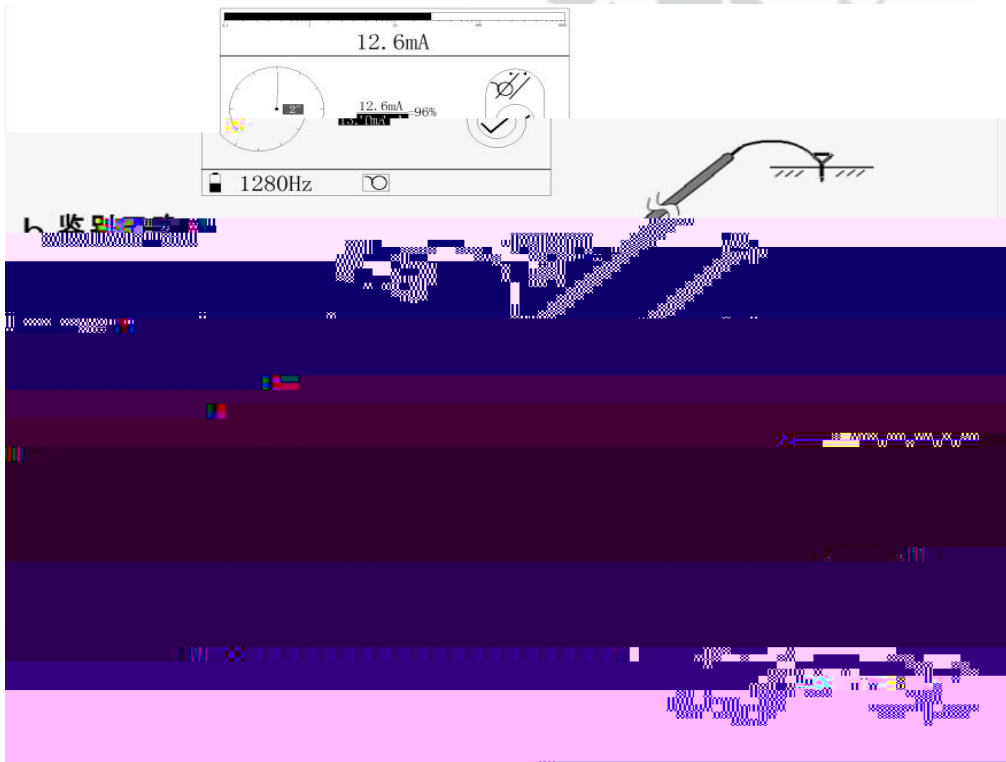

4-1-3

-
-

|

0°

|

225

027-83267669

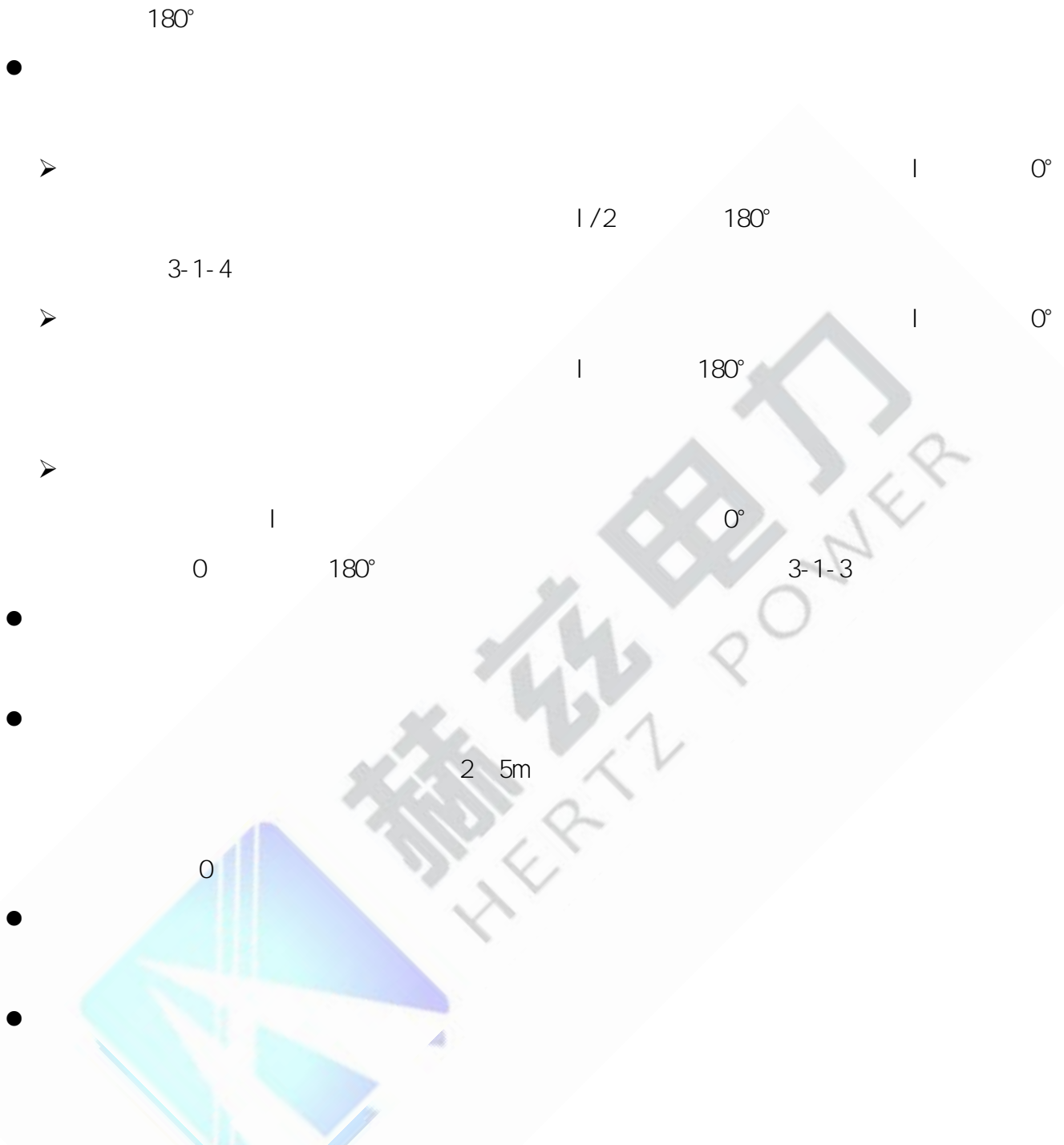

- 1.
- 2.
- 3.

- a)
- b)
- c)
- d)
- e)



4.

1

2

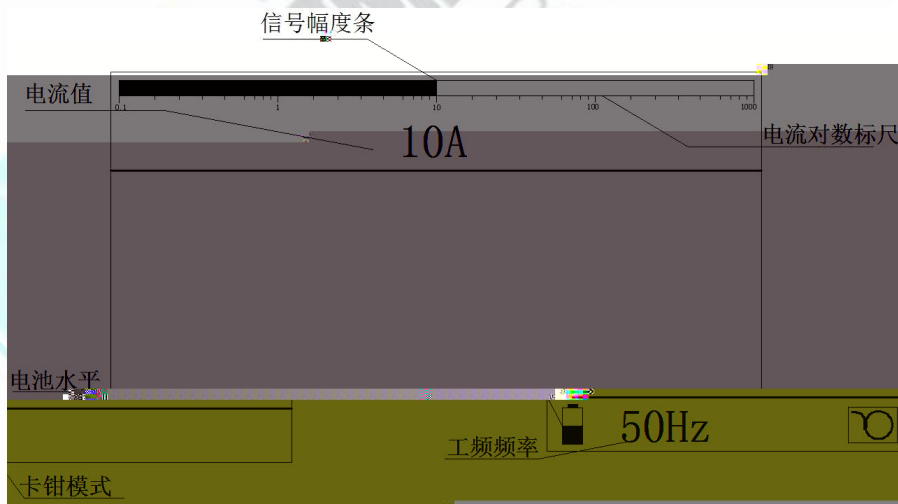

5-1-1

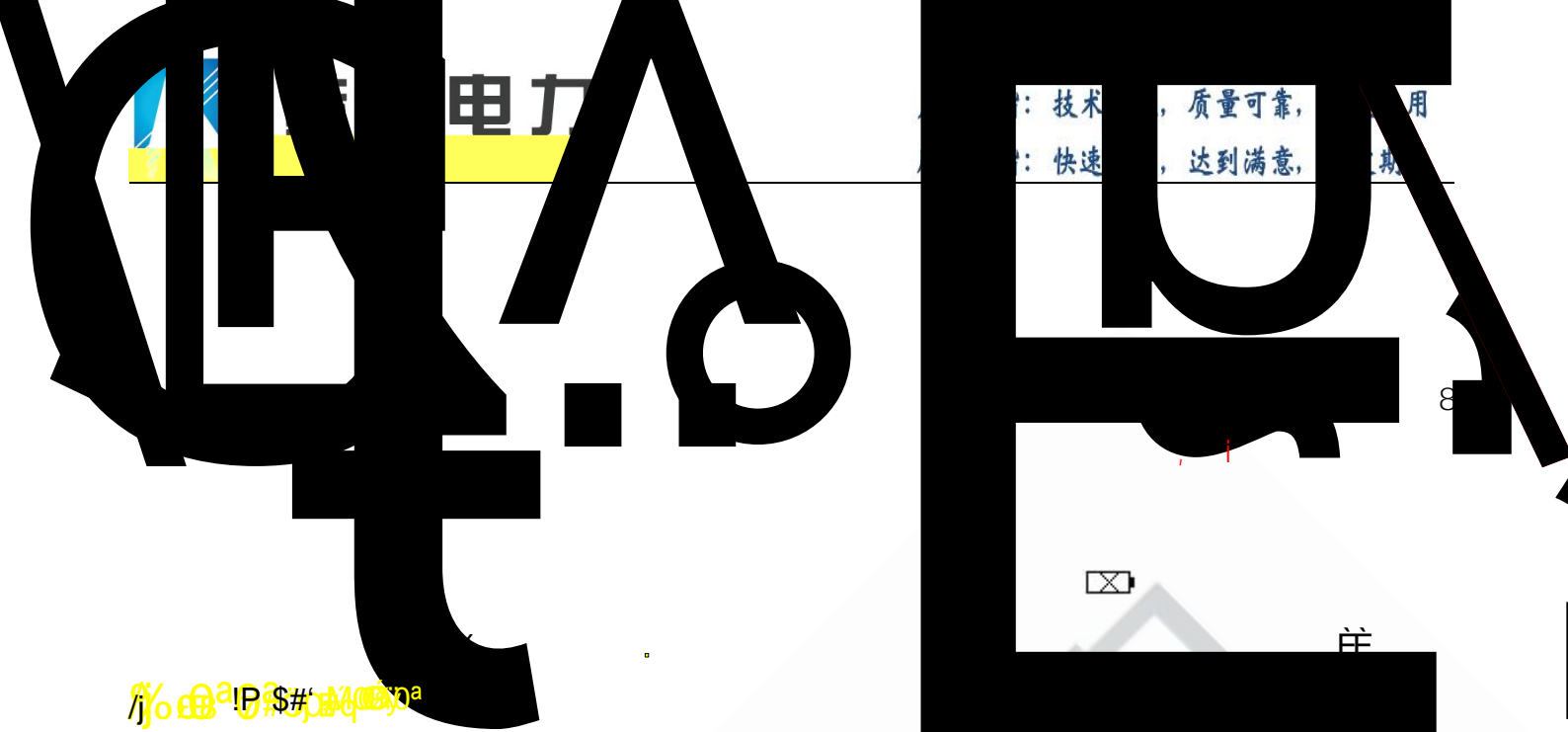

: 技术, 质量可靠, 用
: 快速, 达到满意, 期

!j% @aP\$# 14030a

È6 è

/

" u "

Èu

220V/110V



註



赫兹电力
HERTZ POWER



1
2

1.

2.

1
2

3

027-83267669

4

2

24

24

48

